



Ontario

# Home Security Audit Guide

# Acknowledgement

The Ministry of Community Safety and Correctional Services is pleased to acknowledge contributions from members of the Steering Committee who volunteered their time and expertise to develop this document.

## **The Steering Committee members are:**

- Peel Regional Police - Constable Thomas McKay
- Halton Regional Police Service - Sergeant Kevin Maher
- Ottawa Police Service - Sergeant William Van Ryswyk
- Insurance Bureau of Canada - Kathy Metzger
- The Crime Prevention Association of Toronto - Elizabeth Hawley
- Policing Services Division, Ministry of Community Safety and Correctional Services

#### Message from the Ministry of Community Safety and Correctional Services

The provincial government is concerned about crime and safety and is committed to making Ontario a safer place to live. The Ministry of Community Safety and Correctional Services funds crime prevention programs and promotes partnerships between police and communities to help make Ontario safer.

Crime prevention is everyone's responsibility. With coordinated action and partnerships among the government, community groups and individuals, we can improve the safety of our communities. The ministry is pleased to have worked with police services, business and community groups to develop this guide to help Ontarians in making their homes safer.

Burglary is a crime of opportunity, which you can help control! We invite you to take the Home Security Challenge and reduce your risks.



# Take the Home Security Challenge!

## Is Your Home Likely To Attract A Burglar?

Answer these 10 simple questions and you will have a better idea of whether your home is vulnerable. Then read on to address the areas of your home that are in need of improvement.

### Is Your Home A Target? (pages 3-6)

1. Are there clear views of all windows and doors (i.e. not obscured by bushes or high fences etc.)?

Yes  No

2. Do you ensure that newspapers and flyers are collected, the driveway is shovelled and the grass is cut when you are away for a period of time?

Yes  No

3. Do you leave lights on timers, both inside and outside the home when you are away?

Yes  No

### Nuts and Bolts of Home Security (pages 7-13)

4. Do all of your exterior doors have a deadbolt lock?

Yes  No

5. Do the strike plates (the piece of metal on the door frame that accepts the deadbolt) on your exterior door locks have four (4) screws securing them to the frame?

Yes  No

6. Do all the windows with a single locking device have a secondary security feature?

Yes  No

### Protect Your Valuables (pages 14-17)

7. Do you store your valuables in a safety deposit box or an isolated area of your home?

Yes  No

8. Are your valuables marked with your personal identification number?

Yes  No

9. Do you store your car keys in a location that is out of sight within your home?

Yes  No

### Know Your Neighbours (page 20)

10. Do you know your neighbours across the street and on all three sides of you?

Yes  No

## Results

Please add up the number of "yes" answers you had.

7-10 You are in good shape (you may want to improve on the areas where you answered 'no')

4-6 Your home would benefit from security improvements.

0-3 Your home is vulnerable - Take action!

Your results reflect the level of security your home has in relation to the most common security weaknesses. Review your home security. Recommendations in this guide can be done fairly inexpensively, and the results can be substantial.

*Read on...  
Every home can be  
improved!*



# Introduction

---

People tend to think of burglary in strictly physical terms, that is, illegal access to our home, items taken and/or items destroyed.

However, burglary can have a significant impact on a person's mental well-being. Burglary victims will often speak of a sense of violation. This can lead to feelings of fear, anger and emotional distress, particularly in children and the elderly. To protect your loved ones, your property and your home, you are encouraged to read the pages that follow and to improve the security in and around your home!

This **Home Security Audit Guide** has been developed to provide general information on keeping one's home secure. It is intended to provide guidance in taking precautions to reduce the risk of burglary and minimize the opportunity for crime around the home. Inexpensive and do-it-yourself suggestions are made throughout this document to assist homeowners in maximizing their ability to secure their homes. For further information and assistance, homeowners and community groups may want to contact their local police service or crime prevention association.

# Is Your Home at Risk?

---

## What is the single, most important thing that you can do to protect your property against burglary?

If your answer was *present your home to make it less appealing to a burglar and/or is discouraged from setting foot on the property*, you are on the right track! In order to safeguard your property, you **must** take precautions to ensure that your property always has a lived-in appearance so that it is not noticed by criminals, and they are not enticed to set foot on your property.

Our natural instinct is to think about ways to keep the burglar out, such as upgrading our locks or installing an alarm system. When assessing a property from the street, most thieves do not focus on the type of lock or the type of alarm system on the home. Instead, criminals look for opportunities that improve chances for success. In the case of residential properties, burglars look for:

- Excessive amounts of landscaping and solid wood fences that help them hide from your neighbours.
- Indications that you, the owner, may be away:
  - the presence of flyers, newspapers

- unshovelled driveways
- lawns in need of maintenance
- the absence of a car that is usually parked in the driveway
- the absence of appropriate lighting.

Even the design of your house and its location can have an influence on the criminal's decision to burglarize your home. It is **absolutely critical** that you take a fresh look at the way your property looks to a prospective burglar and that you reduce any opportunity for his/her success. Make sure that the property looks lived in, especially when no one is home.

***Remember, your best defence is to present your property in such away that it does not appeal to a criminal walking your street.*** Burglars look for privacy — homes that conceal them from neighbours or passersby. Overgrown landscaping and too-high fences offer them this opportunity. If a burglar should target your property, your chances for loss could be greatly decreased if you have taken precautions to secure your home (pages 7-13). However, to reduce your chances of becoming a victim, it is vital to get the **big picture** right.

# Getting the Big Picture

---

## Reduce your risk and safeguard your property — think of what attracts a thief!

Look at the big picture items such as landscaping, fencing and lighting.

### Landscaping

Inappropriate landscaping has a greater potential for attracting a thief onto your property than other security factors. Landscaping can obscure windows and doors and provide cover giving thieves an opportunity to move about your property without

being detected. It is critical that you pay close attention to your landscaping. For greater security, follow these do's and don'ts:

- Find out the mature size of the tree or shrub before you plant, then select accordingly. Large trees or excessive shrubs provide spots where adults can hide.
- Avoid fast growing species in favour of slower growing ones that require less aggressive maintenance.
- Perform an annual spring inspection of the landscaping on your property. Pay special attention to the amount of cover your property provides relative to your neighbours.
- Trim/remove excessive landscaping especially around doors and windows.

Criminals are attracted to homes with excessive landscaping or homes in need of routine maintenance which leave the impression that no one is at home.



- Make sure more than one neighbour can see your house. When planting trees/shrubs or erecting a fence, it is a good idea to ensure that your neighbours can see your property from different angles.
- Keep up a regular maintenance schedule that's appropriate for the species planted.
- Don't over plant your property.
- Don't disregard security in favour of privacy.

## Fencing

When selecting fencing material, remember that the more private the area, the more appealing it is to the criminal. A closed six foot high fence, while providing ample privacy, may also provide private space for a burglar. Attempt to balance the need for privacy and security by limiting the amount of “privacy fencing” only to areas where you need it. Excessive amounts of “privacy fencing” can also prevent you from knowing your neighbours and reduce their ability to look out for you!

## Lighting

Lighting or the lack of lighting can draw attention to your residence. For maximum safety and security, your home should have a lived-in look that is consistent from one day to the next. This is best achieved by using timers to maintain at least two visible lights from the front of the house during the hours of darkness when the average person would be expected to be home and awake.

## Motion Activated Lights

During interviews, burglars routinely comment on the presence of motion-activated lights. Motion activated lights are capable of creating a dynamic lighting environment that is effective against trespassers and helps to alert witnesses. The installation of motion-activated lights also sends a message to passersby that the home-owner is security conscious.

*Make sure  
all outside lights  
work.*







In circumstances where only the driveway entrance is visible from the road, it is useful to have a hanging flower basket as this sends a signal that the property is occupied.

## Operation Identification

Operation Identification is a free, **national mark your property program** that encourages the engraving of valuable property with a personal identifying number such as address or telephone number. The Operation Identification program includes window and door stickers that are in the shape of a stop sign. This can deter a burglar from targeting and selecting your property. For more information about identifying your property, see page 16 or contact your local police service.

## Maintenance

We have all come across a house with flyers hanging out of the mailbox and newspapers piled on the front porch. These, along with other obvious signs such as unshovelled snow, uncut lawns, porch lights left on throughout the day or window blinds that are drawn during the day, are tell-tale signs that help make the criminals' job of selecting a target especially easy. Timely maintenance is a critical factor in discouraging criminal activity.

For added comfort and to deter mail fraud, use a locked mailbox and avoid a build-up of mail.





# The Nuts & Bolts of Home Security

## Door, Frames & Locks

Doors, frames and locks are the interrelated basics of home security and are equally important when considering the security of your home.

To be sure that you and your family are protected adequately, make sure that the following security measures are in place.

### Door Security

Making the access doors secure is an important step in protecting your home. Good, solid doors improve your chances in keeping burglars out. When purchasing a door, you should enquire about what the door is made of and how heavy it is. Look for doors without windows or doors that do not have windows within arms reach of the inside lock and handle. If a solid door is already installed, consider installing a peephole so you may look out to see who is at the door.

**Sliding glass patio doors** that are not protected can be lifted out of their tracks for an easy entrance.

The following can prevent the door from being lifted out of place:

- A hockey stick or other piece of wood can be placed in the frame to prevent the door from being slid open.
- A “pin” lock can be attached to the door that goes into the frame.
- Screws can be fastened into the track above the sliding door (when in a closed position).

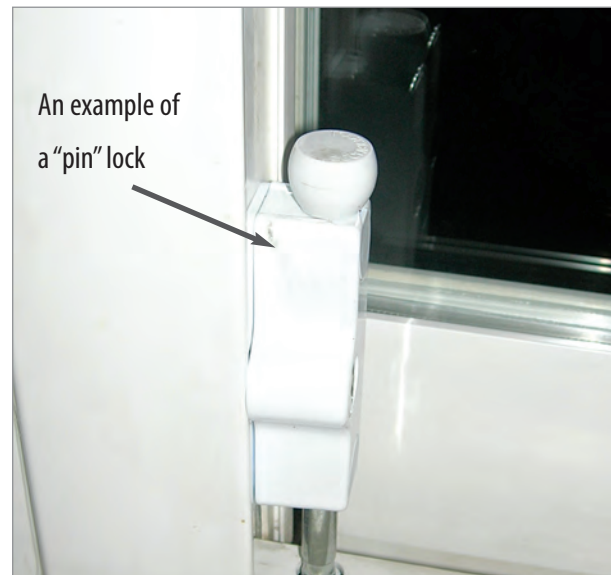

*Remember,  
prevention is key.  
Keep the criminal out  
of your house and your  
property secure.*

Door frames should interlock

A bar, hockey stick, or a piece of wood can be placed securely into sockets to prevent the door from sliding

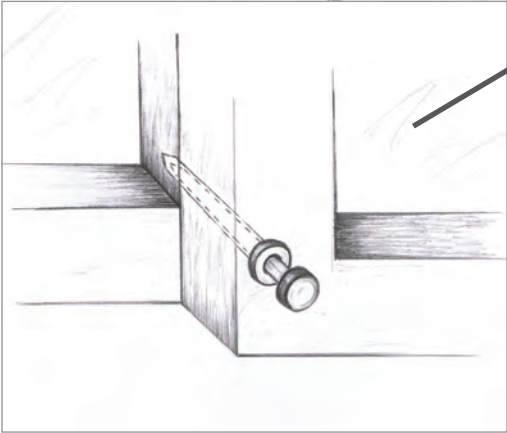

A pin on the bottom of the door will help prevent the door from being lifted

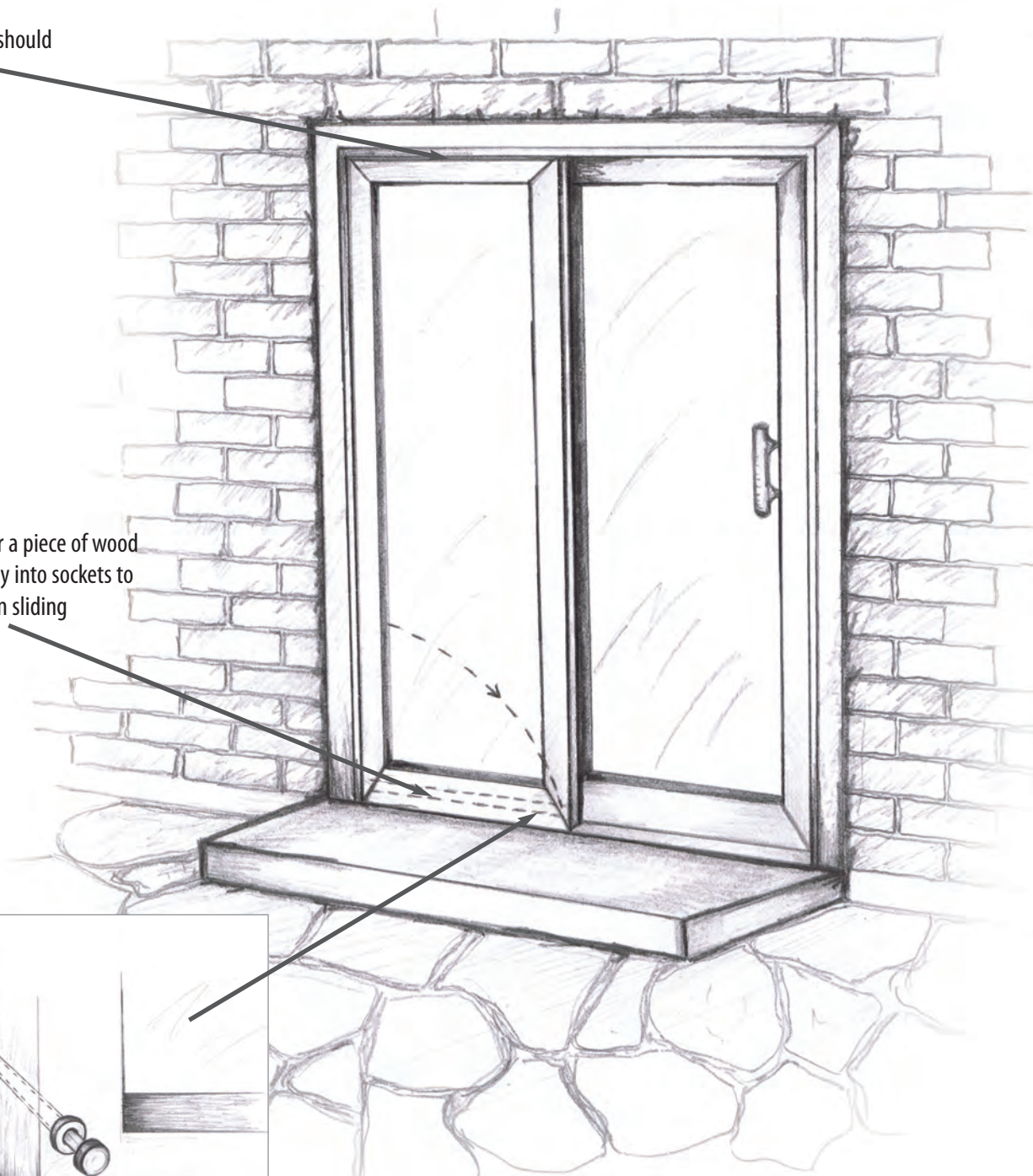



## For Added Protection

For some added protection, you should consider installing a u-shaped escutcheon plate around the lock set at the door's edge. This will help to prevent entry from prolonged kicking or extreme pressure.

For maximum effectiveness, the plate should be secured from the inside with 1.9 cm (3/4 inch) screws that cannot be removed from the exterior. This will likely require re-drilling the screw holes found on the escutcheon plate.

**Charlie bars** are designed to prevent lateral movement in patio doors. They are installed at a convenient height and create a visible deterrent to burglars. *Charlie bars are available at most hardware and home improvement centre and are an excellent security option.*

## Locks

A secure lock is an important step in keeping a burglar out of your home. A deadbolt lock should be placed on all access doors including the door that provides access to your home from the garage. Here are a few important features you should consider when choosing an appropriate deadbolt (*check with your local hardware store or locksmith for more information*). Locks should be:

- pick-resistant
- drill-resistant
- saw resistant
- twist-resistant, with tapered hardened steel, or free spinning cylinder guard
- minimum of 2.5 cm (1 inch) long when thrown
- inter-locking bolts should be a minimum of 5.6 cm (2 1/4 inches).

Deadbolt locks that require a key from both sides are not recommended – they do not allow for a quick exit in the event of a fire.

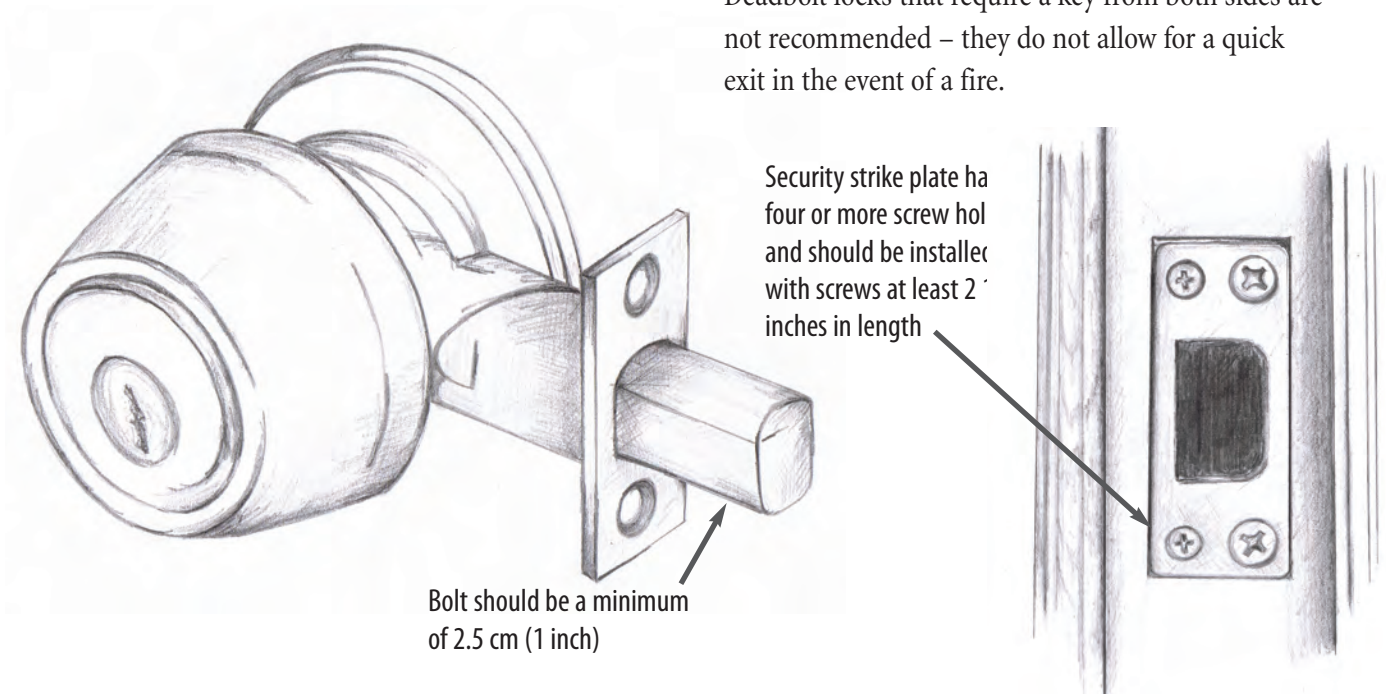

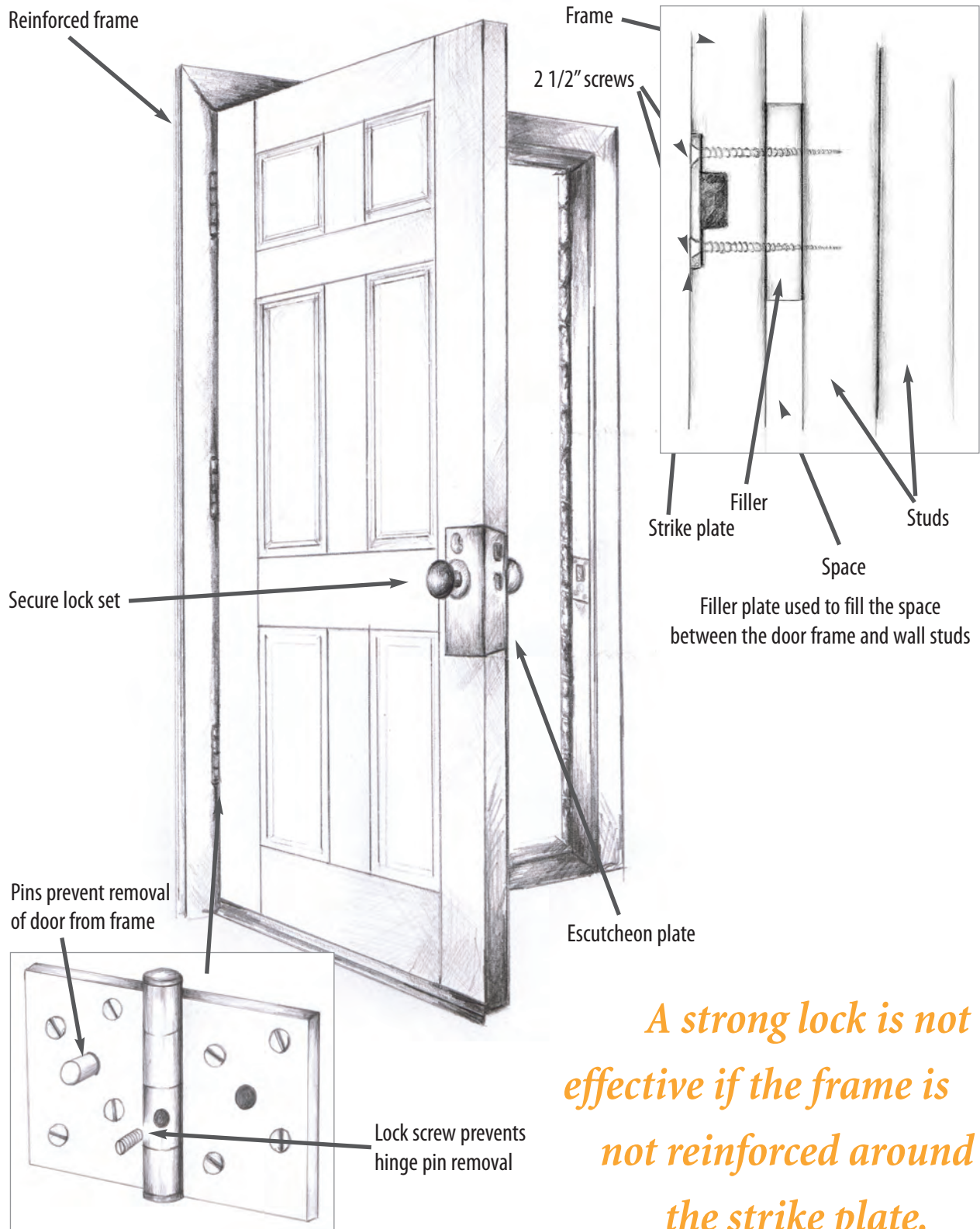

---

## Frames

The doorframe is a critical, yet often overlooked, component of home security. Even the best locks can be rendered ineffective if basic measures are not undertaken to reinforce the frame. To make sure that your frame provides adequate security, a security strike plate should be installed with screws that are at least 2 1/2 inches in length.

*(Note: Security strike plates can be distinguished from conventional strike plates due to the presence of four or more holes.)*

It is important to recognize that the frame, door and lock must work together in order to resist physical attack.

A properly secured strike plate secures the frame and transmits the force of any attack to the door. Without reinforcement the door can be pried open by bending the frame or the door can be kicked in. A burglar is not concerned about the damage caused and will use as much force as is necessary to open the door quickly.

## For Added Protection

A space may exist between the door jamb (the piece of wood that the strike plate is screwed into) and the wall stud that supports the frame. For added protection, reinforce your door frame with a filler plate so that your lock cannot be pried open.

# Windows

## Homeowners need to ensure that all the windows of their home are resistant to break-in attempts.

Windows can be smashed, pried open and lifted off their tracks. Dead bolt locks that can be reached from a window can give a burglar access to a home. The following measures are necessary to ensure that you have adequate window security.

## Sliding Windows

Slider style windows are those that slide side-to-side on a track. They can also be lifted up and out for installation and routine maintenance which tends to make them especially vulnerable to criminal attack. The security of sliding windows should be upgraded.

To prevent the windows from being moved side-to-side:

- Cut a snug piece of wood the size of a broom handle or hockey stick to fit between the outer window frame and the edge of the sliding portion of the window, or add a secondary lock that secures the sliding portion of the window to the fixed portion. This type of product can be purchased at a hardware store or installed by a locksmith/contractor.

To prevent the window from being lifted up and out:

- Cut a piece of wood to fill the gap between the top of the slider and the track above. The wood should be slightly smaller (about 1/8 inch) than the actual gap and be as long as the sliding portion of the window. Alternatively, two or three screws can be inserted into the portion of the upper track above the window that is used for ventilation (the window behind the screen).

### Double Hung Windows

Double hung windows slide up and down on a track. They can be forced open by applying pressure to the lock area. The security of these types of windows can be greatly improved by adding a secondary locking device and/or installing a metal pin or nail through both sides of the window. Specialized security pins designed specifically for this purpose can be purchased at hardware stores.

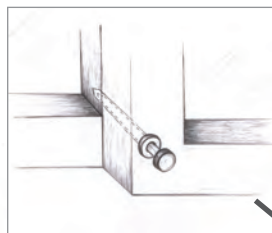

A pin or nail prevent the window from sliding

### Casement/Awning Style Windows

Casement and awning style windows are those that are opened by the operation of a roller style handle. These types of windows are generally quite secure when properly locked with the factory installed locking mechanisms. To improve the security, remove the handle and store it out of sight.

### Sidelights

Sidelights are those windows commonly found next to doors. Any window within 40 inches of a door handle should be reinforced.

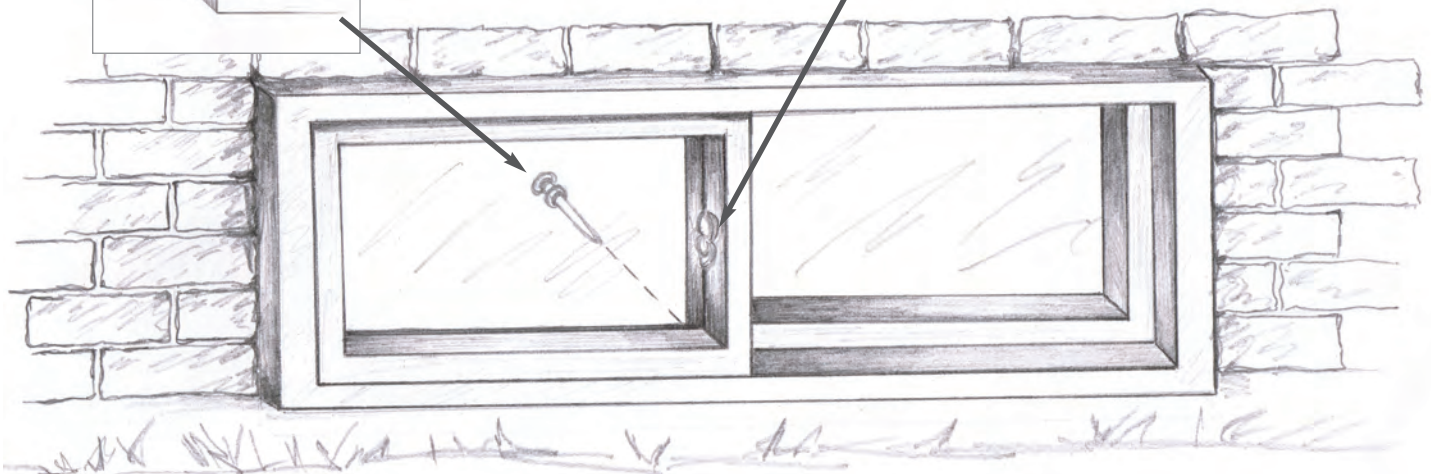
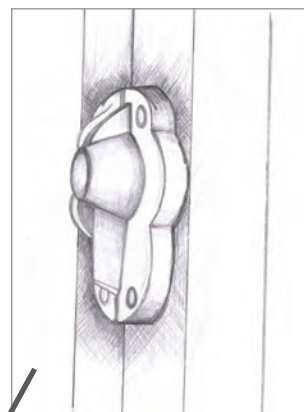



---

## For Added Protection

### Consider Strengthening the Glass

Thieves often break glass to obtain access to locks. This is particularly true of basement windows and the glass in and around doors.

### Bars

Bars are sometimes used to secure windows and doors. If you choose bars as a security measure, make sure that:

- the bars are equipped with a quick release mechanism. Consult your fire department for more information.
- the screws used to install the bars are not accessible from the outside.

### Laminates (films)

To increase the resistance of your windows to burglary, contact a professional to install a security laminate film. Laminate professionals are listed under Glass Tinting & Coating in the Yellow Pages of your phone book.

### Polycarbonate

Polycarbonate (a rubberized, clear, unbreakable plastic) can also be used as a substitute for bars, provided that it is properly installed. Polycarbonate is available at home renovation centres and is listed under Plastics in the Yellow Pages of your phone book.



# Protect Your Valuables

Homeowners can limit the overall impact of a burglary taking the following step.

## Don't Advertise Your New Purchases!

If you have purchased big value items, (e.g. TVs, stereos or computer equipment), be sure to fold the cardboard box inside out before placing it in the recycling bin. This keeps the identity of your purchases private and does not alert would be burglars of the contents of your home.

## Where Do You Keep Those Items With Sentimental Value?

Make a list of the items in your home that are irreplaceable and keep them in a safe place. When not in use, the items should be stored in a place no one would suspect. For example, jewellery that has been passed down through generations should not be kept in a jewellery box – this is the first location a burglar will look. A safety deposit box or a permanent safe within your home could be used. If you have a safe in your home, it should be kept in an isolated location – away from the main traffic areas.



*Keep your valuables in a safe place, such as a safety deposit box.*

---

## Is Your Vehicle A Target?

Manufacturers are making vehicles harder to steal with the use of anti-theft systems. As a result, professional vehicle thieves are stealing car keys. Protect your vehicle by keeping the keys in a secure location. There are a couple of things you can do to protect your vehicle:

- Do not leave your keys where they are easily found. For example, keys should not be left at the front door! It is quick and easy for a car thief/burglar to take keys that are in plain view.
- Always keep your vehicle locked, regardless of where it is parked.
- If you have a garage, park your car in it so that the vehicle cannot be seen and not identified as a target.
- Always keep your garage locked.

## What's In Your Wallet?

The contents of your purse or wallet are extremely valuable. Your identification, credit cards, health cards and other valuable items are all kept in this one convenient spot. Leaving your purse or wallet near the front door makes it easy to grab. **Keep them in a convenient, yet out of sight location.**

*Keep your  
keys out of sight,  
in an unsuspecting  
location.*





---

To avoid losing your identification or credit cards and limit your exposure and the inconvenience if a theft does occur:

- Do not carry your social insurance card and birth certificate in your wallet – they are generally not required as identification.
- Limit the number of credit cards you carry.

*Property that is easily identifiable is harder for the criminal to sell.*

### Can You Identify Your Property?

Each year, the police auction thousands of unmarked property items that were either lost or stolen. Engrave your valuables with a personalized identifying mark. These markings should be in plain view and easy to spot. Items with identifiers are less valuable on the black market and burglars are less inclined to take them. The police use these unique markings to identify the owner of stolen property they retrieve from criminals.

To mark your valuables, create your own unique identifier of at least eight characters (e.g., a phone number).





---

If a theft does occur and your property is located by the authorities, you will want to be able to identify and claim what is yours. To simplify this process, you should:

- Take an inventory of the items in your home, garage and tool shed.
- Take photos or video recordings to show what you own.
- Write down the serial numbers.
- Keep receipts for the more expensive items.

Keep this information and a record of your identifying number in a safe location separate from the actual property, preferably in a fire resistant safe or a safety deposit box. This information will be useful when making a claim to your insurance company as well!

### Items Most Frequently Stolen

Thieves prefer to take smaller items that can be easily pocketed. Favourite items taken by thieves include:

- Jewelry
- Cash
- Camera equipment
- DVD/CD players
- TV/VCR/DVD recorders.

*Thieves prefer  
to take small items  
that can be  
easily pocketed.*



# Going Away On Vacation?

---

Your home is most vulnerable when you are away for an extended period of time. Be sure to practice good crime prevention techniques when away so you come back to a house that is as safe as you left it.

It is strongly recommended that you have someone you trust check your home and pick up your mail and papers while you are away on vacation. That person should be provided with information on when you are leaving and when you expect to return. If you decide to come home early or stay longer, be sure to also keep that person informed.



For a small fee, you may also request the Post Office to hold your mail until you return from vacation. It is also advisable to review your home insurance policy for information or requirements that the insurer may have on the length of time your home may be vacant.

A lived-in look will give an outsider the impression that someone is at home. While you are away, it is advisable that you have:

- The driveway shovelled in the winter and your grass cut in the summer.
- Lights on timers that would normally reflect your daily activity.
- A neighbour park a car in your driveway.
- A neighbour put some of their garbage at the end of your driveway on garbage day.

Making arrangements to have these normal daily routines continue while you are on vacation will give a potential burglar the impression that the home is occupied because your routine does not appear to have been changed.

*When away on vacation remember to have someone pick up your mail and newspaper.*

# Canvassers & Door-to-Door Sales People

It is important to remember that someone who comes to your door to sell something or ask for donations may not always be legitimate.

Most homeowners have had experience with canvassers or door-to-door sales people. You should be very careful when dealing with canvassers and door-to-door sales people. If you do not know the person at the door, you are under no obligation to open it to them. Let them know you are home by saying, **“We cannot come to the door right now.”** This way they are aware that the house is not vacant.

- Do not let strangers into your home to use the phone.
- Do not give in to high-pressure tactics. Take your time and get a second opinion if necessary. Check references to ensure the professional reputation of the firm.
- If you are unfamiliar with the charity represented by the canvasser, you may wish to ask for information and call the charitable organization. This gives you the opportunity to determine if the canvasser is legitimate and decide whether this is a charity of your choice.

*Do not feel obligated to invite a stranger into your home.*





# Know Your Neighbours & Your Neighbourhood

## Knowing your neighbours and neighbourhood is a great way to reduce crime in your community.

Community partnership/involvement is key to minimizing crime and maintaining a safe and healthy place in which to live. Crime does not thrive in a healthy, involved community. You can get your community involved by hosting a social function like a pot-luck or street barbeque. This allows you an opportunity to meet your neighbours and to know who belongs in your community. You can also speak to your neighbours about keeping a record of their phone numbers and email addresses to help keep your neighbourhood current on local events and any

crime concerns that may arise. Call your local police or Neighbourhood Watch program for more helpful hints.

Encourage your neighbours to report suspicious behaviour to police immediately. If you notice someone parked in a car for an extended period of time or continuously driving around the same neighbourhood, call the police. If you see someone going into a neighbour's back yard or trying the doors or windows, call the police immediately. If in doubt, call the police and ask their advice.

Emergency phone numbers should always be placed somewhere visible and easily accessible. For a list of important numbers, look in the front of your phone book and update the numbers as required.

Speak to your neighbours about keeping a record of their phone numbers and email addresses to help keep your neighbourhood current on local events and any crime that may arise in your community.





# Some Myths & Realities of Home Security

---

Almost everyone has an opinion on trends in burglary, why burglaries occur, or how to prevent break-ins. Here are answers to a few myths about burglaries.

**Myth: Most residential burglaries happen at night.**

Most residential burglaries happen during the day when the majority of people are not home.

**Myth: A chain lock offers good security.**

People buy chain locks with the belief that they offer adequate protection when they answer the door. Chain locks offer little protection against the threat of forced entry and can result in a false sense of security when a superior lock is disengaged. A peephole on your door is preferred because it will allow you to see who is outside your door while preventing the person from seeing inside your home.

*A chain lock offers a false sense of security and is NOT a recommended method for home security.*



---

## Myth: An alarm system is all that I need to protect my home and my family.

Unfortunately, this view is not shared by the average thief, and the homeowner may still be at some risk. Residential alarm systems offer an increased level of security and some deterrence to the criminal. However, they should not be considered as exclusive replacements for other home security measures but should be used in conjunction with them.

### What You Should Know

- Police do not directly monitor burglar alarm systems. It may take a couple of minutes before the call is directed to the police.
- Because of other crime prevention priorities, police cannot always treat residential alarm calls as a high priority. Check with your local police about their policy on responding to alarm calls.
- Burglars spend between three to four minutes in a home, and, in most cases, the criminal will be gone before the police arrives.
- Most alarms will alert the alarm company through your phone line. This may render your phone line unusable. If you are home when someone tries to break in into your house, it may be impossible for you to call for immediate help. If you have an alarm system, you may want to consider adding a second phone line. Check with the alarm provider on how your phone line is used.



*Alternatively, an exterior mounted alarm with a flashing strobe light may be used. This may alert neighbours to contact the police and scare off the thief. Homeowners would need to verify that there are no bylaws or city codes restricting the use of this feature*

# Crime Stoppers

---

Crime Stoppers is a partnership of the public, police and media which provides the community with a proactive program to anonymously assist in solving crime and contributes to an improved quality of life.

Crime Stoppers is an effective tool for citizens to anonymously report crime. The long established hotline number 1-800-222-TIPS is used throughout North America and is available 24/7.

Crime Stoppers guarantee of anonymity, promise not to appear in court as a witness and the offer of a reward for information that solves a crime has proven to be effective.

Crime Stoppers is a not-for profit community-based charitable program. Crime Stoppers encourages the public to call with information concerning crimes that have been committed, are being committed or are about to be committed. Crime Stoppers has become an invaluable investigative tool to police services.

In Ontario, there are 38 community Crime Stoppers programs covering the entire geography of our

province. The impact of this crime fighting network in Ontario has been astounding! Since the first programs in Ontario started in 1983, the statistics for the 38 Boards in Ontario show that Crime Stoppers works. As a result of calls to Crime Stoppers, there have been over 75,000 arrests and more than 115,000 cases cleared. The value of illegal drugs removed from our streets is close to \$1.5 billion. The value of stolen property recovered as a result of calls to Crime Stoppers is close to \$275 million.

Statistics show an average conviction rate of 95 percent and tips to Crime Stoppers save law enforcement agencies thousands of dollars in investigation time. Calls to Crime Stoppers assist in putting police on the right track by identifying individuals who are responsible for committing crimes.

Members of the public with information about property crime and burglary who want to remain anonymous can call **Crime Stoppers at 1-800-222-TIPS.**





# Home Security Tips

---

To a criminal, there are certain indications that a home is vacant or a better target for a break and enter.

Below is a list of suggestions to reduce your risk of becoming a victim.

1. When you move to a new home, you should change or re-key the locks immediately.
2. Always keep your front door locked.
3. Keep screen doors locked whenever your main door is open.
4. Never ignore a knock on the door.
5. Garage doors leading directly into the home should be kept locked at all times, even when you are in the house or backyard.
6. Chain locks are NOT recommended as security for doors. Instead, invest in a peephole which allows you to look out but does not allow the person to see inside.
7. Limit the size of accessible window openings. If they are being used for ventilation at night – install a securable, window stop.
8. Lock ladders to the house, fence or inside a shed or garage. Unlocked ladders can be used to gain entrance through a second story window.
9. Be sure second story windows are closed and locked when you are not at home. Patio furniture has been used as a stepladder to gain access to upper levels of the home.
10. Trim hedges below the window level to eliminate hiding spots for criminals.
11. Make sure that outside lights are in good working order.
12. Engrave an identifying mark on your property. This makes it easier for police to identify and harder for criminals to sell.
13. Keep objects with sentimental value in a place no one would suspect when not in use.
14. Take inventory of your property. Use photos or videos and/or DVDs.
15. Lock your vehicles at all times, even when in the garage, so access cannot be gained by intruders. Secure bicycles by obtaining the serial numbers and or identifiers then registering your bicycle with your local police service.
16. Keep your vehicle keys out of sight and in a location where no one would look for them.
17. When new items like TVs, stereos or computer equipment are purchased, be sure to fold the cardboard box inside out before placing in the recycling. This means your new purchases won't be advertised to anyone on the street.
18. Don't allow strangers into your home.
19. Know your neighbours.
20. Make sure that your home always looks lived in (e.g., newspapers/flyers picked up, grass cut, snow shovelled etc).
21. When leaving a message on your phone or answering machine, do not indicate that you are not home.



# Home Security Reference

## Know Your Neighbours

Keep a record of your neighbours' telephone numbers. Using the the table below, start a phone tree and get to know the people in front, behind and on either side of you.

### Emergency 911

NEIGHBOUR _____ ADDRESS _____ PHONE# _____	NEIGHBOUR _____ ADDRESS _____ PHONE# _____	NEIGHBOUR _____ ADDRESS _____ PHONE# _____
NEIGHBOUR _____ ADDRESS _____ PHONE# _____	<b>MY HOUSE</b>	NEIGHBOUR _____ ADDRESS _____ PHONE# _____
NEIGHBOUR _____ ADDRESS _____ PHONE# _____	NEIGHBOUR _____ ADDRESS _____ PHONE# _____	NEIGHBOUR _____ ADDRESS _____ PHONE# _____

### Other Important Numbers

_____	_____	_____
_____	_____	_____



